

This drawing is the property of Cathodic Anodes Australasia. To be used with permission only. This drawing becomes an uncontrolled document once issued as hard or electronic copy. Customer to confirm current revision of drawing prior to ordering.

4 x M5 x 16mm 304 S/S Socket Head Cap Screws

4 x M5 304 S/S Internal Tooth Washers

TAP - 4 x M5

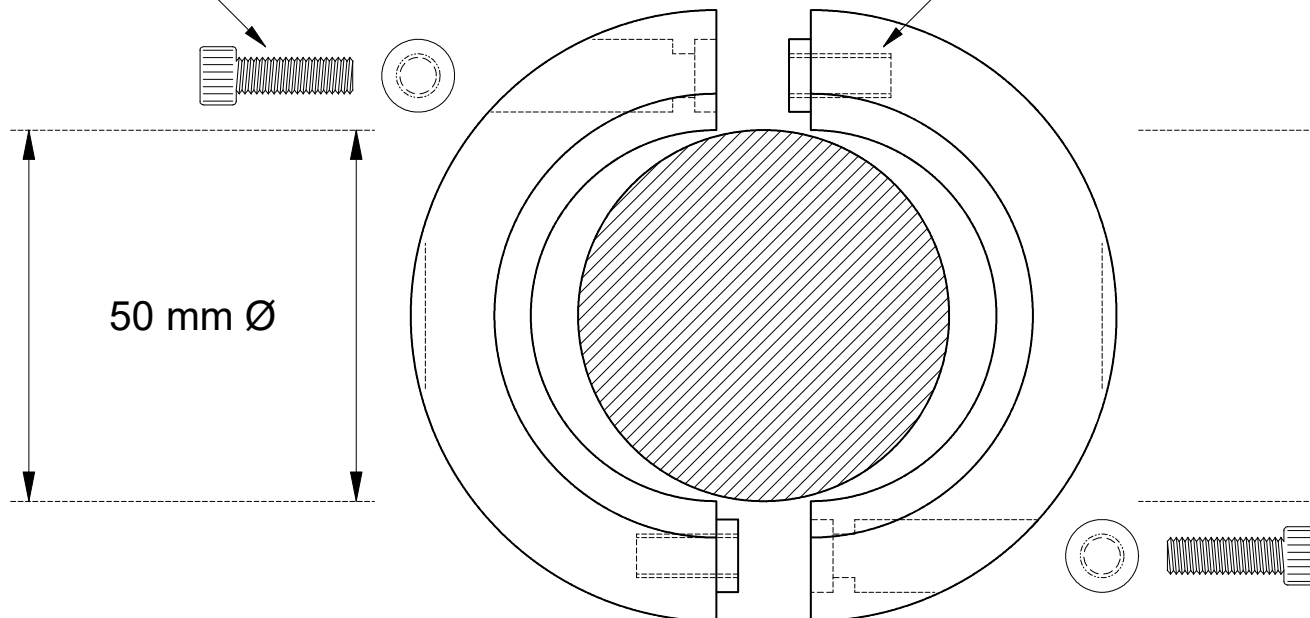
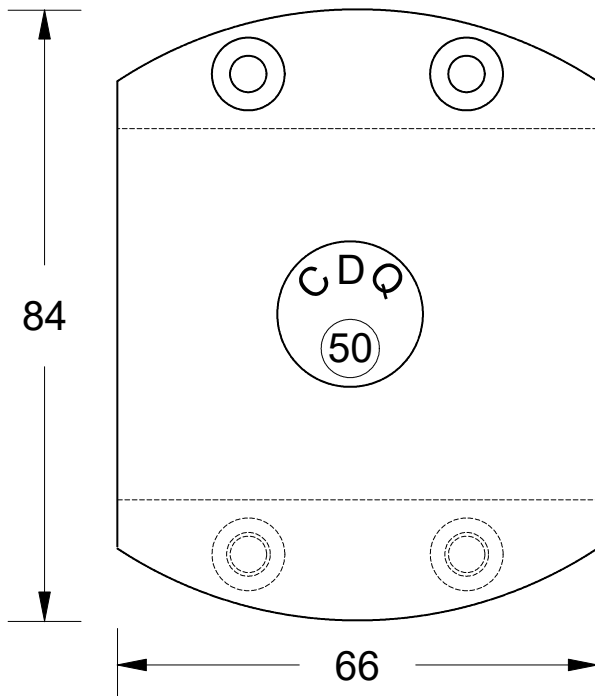

Intended Use For 50 mm METRIC Shafts

Chemical Composition Limits		Alloy:
Standard: AS2239* (Most current revision)		Z1
Zinc		
Element	min.	max.
Cadmium	0.025	0.07
Aluminium	0.10	0.50
Silicon	-	0.005
Copper	-	0.005
Iron	-	0.005
Lead	-	0.006
Other Impurities		
- each	-	0.005
- total	-	0.02
Zinc	remainder	

* Corresponds to MIL-DTL-18001L alloy composition

Notes

1. Anodes are cast to comply with CAA's standard casting tolerances
2. All sharp edges removed for safe handling
3. Anode insert material to meet relevant Australian/International specifications



Rev	Details of Change(s)	Date	Drawn	Verified
1	Cathodic Diecasting Original	06 September 2011	R.N.	R.G.
2	2013 Catalogue Version (CAA Logo)	18 December 2015	R.N.	R.G.

Nett Weight Kg (nominal)	Gross Weight Kg (nominal)
1.15	1.20



Cathodic Anodes Australasia

cathodicanodes.com.au

Product		Scale	
Zinc Anode - Shaft Anode		1 : 1	
Part no.	CDZ4 - 50M	Rev	Sheet
Drawing No:	CD3172	2	1 of 1
Drawn by: R Northey	Date: 18 DEC 2015		

All dimensions are in mm (nominal)